







# Kabelkonfigurator

## PADCON Float Controller CI

### Kabelvarianten

Kabel Nr.	Kabel Typ	Länge	Anschlüsse	Beschreibung
①		0,5m	offen / MC4 Stecker	Anschlusskabel Wechselrichter (Messung + / Pull up)
②		1m	MC4 Buchse / MC4 Stecker	Verbindungskabel mit eingegossener 5A Sicherung (Modulseite mit positiver Spannung)
③		3m / 5m / 10m	MC4 Buchse / MC4 Stecker	Distanzkabel (Messung + / Pull up)
④		0,5m	MC4 Buchse / MC4 Stecker	Verbindungskabel FC zu MC (Pull up)
⑤		0,5 m / 3m / 5m / 10m	offen / MC4 Buchse	Anschlusskabel Wechselrichter (Messung -)
⑥		3m / 5m / 10m	offen / MC4 Stecker	Anschlusskabel Wechselrichter (Messung + / Pull up)
⑪		0,4m	MC4 Stecker / MC4 Stecker MC4 Buchse	Y- Kabel +

### Bestellung

Kabel Nr.	Länge	Anzahl

Kabel Nr.	Länge	Anzahl

Bitte senden Sie dieses Formular ausgefüllt per Fax, Post oder Email an PADCON GmbH.

**PADCON GmbH**  
Gräseleinsgasse 1  
97509 Koltitzheim  
Germany

Tel.: +49 (0)9321 2680 - 201  
Fax: +49 (0)9321 2680 - 9201  
E-Mail: [info@padcon.com](mailto:info@padcon.com)  
Home: [www.padcon.com](http://www.padcon.com)

# Kabelkonfigurator

## PADCON Float Controller CI

### Float Controller

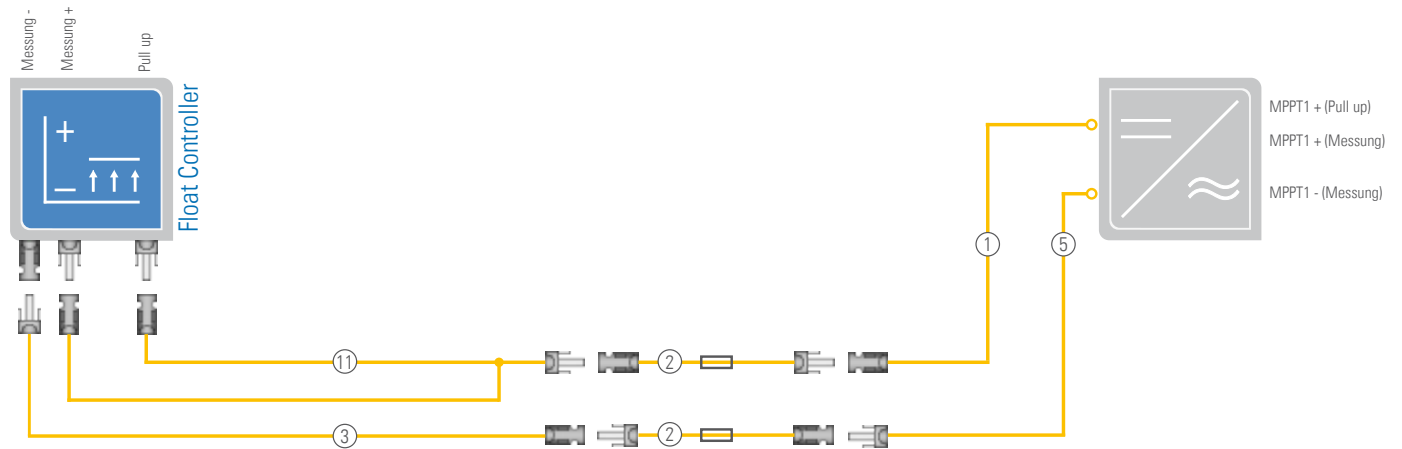

### Float Controller mit Multi Connector

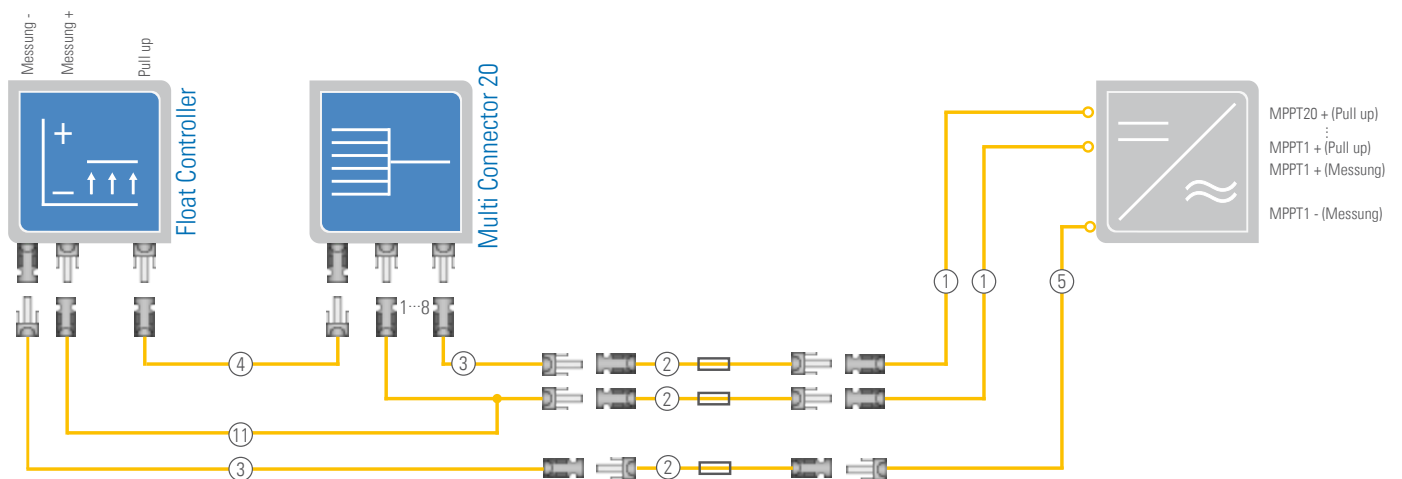

### Compact Station

